

REV.	ECN NO	LOCATIONS	DESCRIPTION	DATE

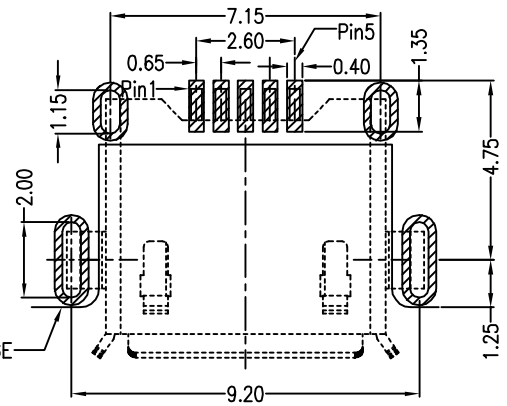
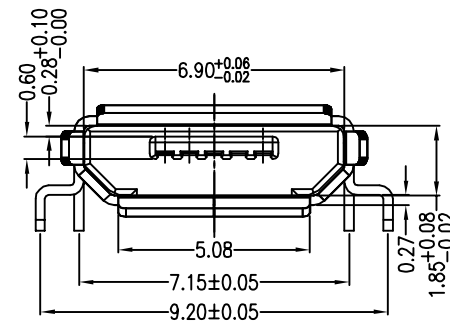
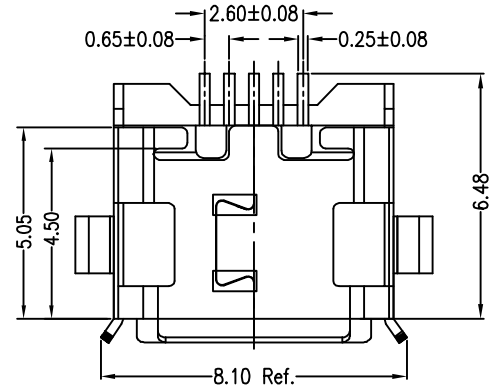
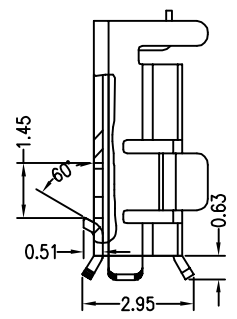
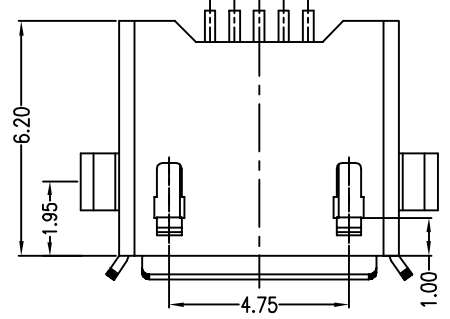
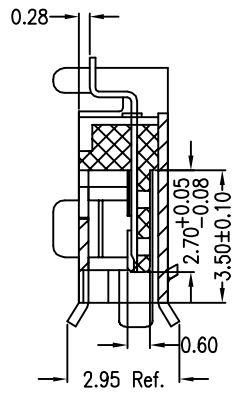
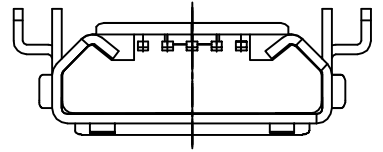

RECOMMENDED PCB LAYOUT

- Note:
- Material:
 - Housing: High temperature thermoplastic with g.f,UL94v-0
 - Contact: copper alloy,t=0.15mm
 - Shell: copper alloy,t=0.25mm
 - Specification:
 - Current rating: 1 A Max.
 - Dielectric withstanding voltage: 100 V(ac) for 1 min.
 - Contact resistance: 50 mW Max.
 - Insulation resistance: 100 MW Min.
 - Total mating force: 3.57 Kgf Max.
 - Total unmating force: 1.0 Kgf Min.0.81~2.05 Kgf Min.after 10000 insertion/extraction cycles
 - Temperature range: -30°C~80°C

PART NO: HW-MUSBF-005-003		MATERIAL: SEE NOTE		东莞市鸿威精密电子有限公司 Dongguan HongWei Electronic CO.,LTD	
MODEL NO: XX		FINSH: SEE NOTE			
UNIT: MM	SIZE: A4	COLOR: SEE NOTE		TITLE: Micro usb 5s B Type 四脚全插 (破板0.27)	
TOLERANCE UNSPECIFIED		DR: 夏友红		DWG NO: A229	
.x	0.25	CHK:		REV: A	
.xx	0.15	APP:		SCALE: 5:1	
.xxx	0.10			DATE: 2012.05.22	
Ang.	2'				