

PLUG 完全插入后,
CONN.前端与PLUG根部尺寸

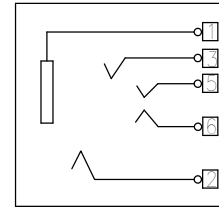

SCHMATIC

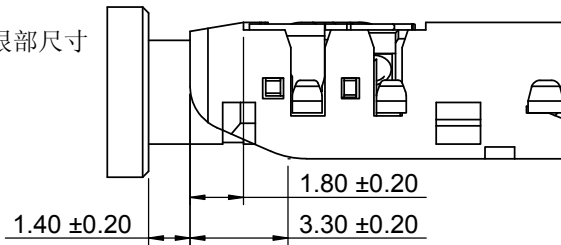
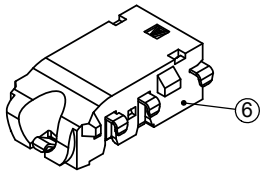
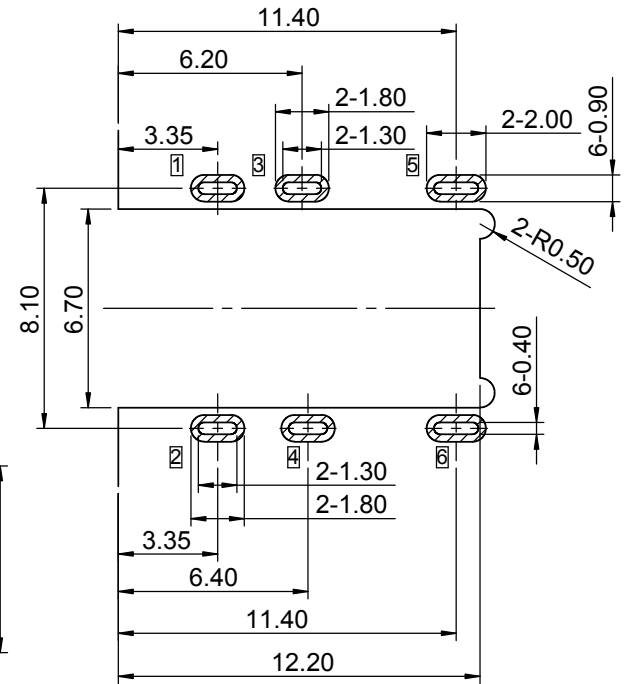

PCB LAYOUT(TOP VIEW)
TOLERANCE ±0.05

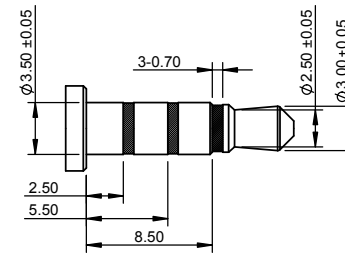
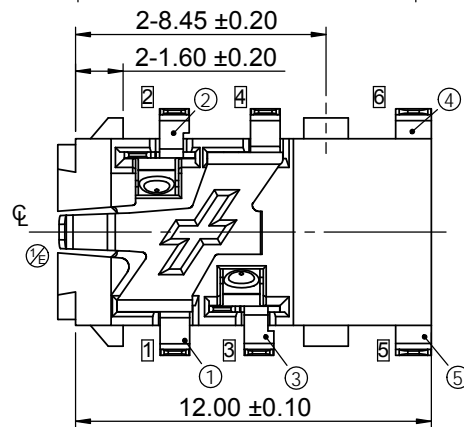
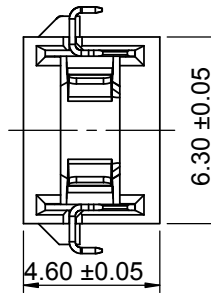
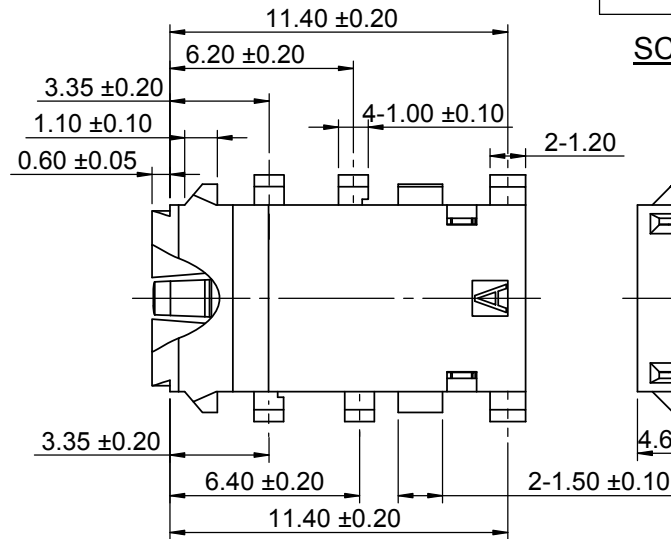
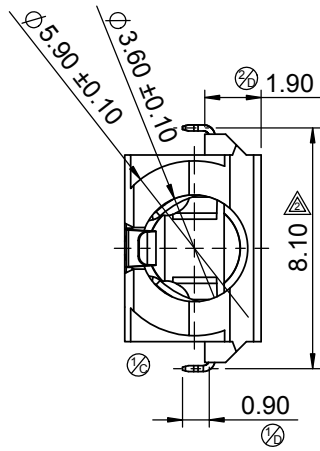

Ø 3.50 mm 4 POLE PLUG
DETAIL DRAWING

NOTES:

1. CONTACT CURRENT RATING: 1A.
2. CONTACT RESISTANCE: 50 mΩ MAX.;
3. INSULATION RESISTANCE: 100MΩ MIN.;
4. DIELECTRIC WITHSTANDING: 500V AC MIN.;
5. DURABILITY: 5,000 CYCLES MIN.;
6. CONNECTOR MATING FORCES:
29.4N (3.00Kgf) MAX.;
7. CONNECTOR UNMATING FORCES:
2.94N(0.30Kgf) MIN.;

NO.	DESCRIPTION	MAT,L	COLOR	REMARK
6	HOUSING	HIGH TEMP	BLACK	
5	TERMINAL 5	COPPER ALLOY		Au PLATED
4	TERMINAL 4	COPPER ALLOY		Au PLATED
3	TERMINAL 3	COPPER ALLOY		Au PLATED
2	TERMINAL 2	COPPER ALLOY		Au PLATED
1	TERMINAL 1	COPPER ALLOY		Au PLATED

东莞市鸿威精密电子有限公司
Dongguan HongWei Electronic CO.,LTD

TITLE: Ø 3.50 mm PHONE JACK CONNECTOR

PART NO. HW-PJ-301-001

PRODUCT SPEC. RD-W06

FILE NAME.

SCALE 4:1 UNIT:mm A4 SHEET: 1 of 2

ECN NO.	REV	DATE	DESCRIPTION	CHANGE	APPRO.	GENERAL TOLERANCE UNLESS OTHERWISE NOTED	DESIGN	DATE
JH2013-014	F	03/06/13	F1:图面规范化	彭志况	罗志兵	Angle ±2° X ±0.50 .X ±0.30 .XX ±0.15	彭志况	03/06/13
JH2013-001	E	01/10/13	E1:变更结构	彭志况	罗志兵			
JH2012-053	D	11/17/12	D1~D2:变更结构	彭志况	罗志兵		谭艳斌	03/06/13
							罗志兵	03/06/13